

## OELOGAMP8304

### Photo Diode Monitor LogAmp AD8304 Board

#### GENERAL DESCRIPTION:

The OELOGAMP8304 photodiode monitor board provides a high-performance and user-friendly means of monitoring photodiode current. The output voltage signal range is -0.2V to +4.0V based on the logarithmic conversion of the photocurrent. This board mounts the AD8304 logarithmic amplifier to achieve high sensitivity and low noise. At the 1nA photocurrent level, the AD8304's bandwidth is about 2 kHz, and can reach 10 MHz at higher current.

This board has two types of output ports, one at 4V and the other at 2.5V. The 2.5V output port has gain 1.47V/V, and 294 mV/decade of logarithmic slope. The 4V output port has a gain of 2.47V/V, and 494 mV/decade of the logarithmic slope.

Supply input voltage is +5V. The board provides three power supply output ports. One at +5V (0.4Amax), another at +3.3V (0.4Amax), and yet another at -5V (70mAmax).

Photodiodes can be mounted on two types of through-hole type pads. The recommended photodiode package is the PIPD (Oplink Communications Inc.) series with Package 3 or 4 (PIPD-XXXX-XX-0-(31or42)-XX).

The AD8304 provides a bias for the photodiode that varies linearly with the current which adaptively minimizes dark current. The bias ranges from 0.1 V reverse bias at  $I_{PD}=100$  pA, 2 V at  $I_{PD}=10$  mA.

A 15 Hz output pulse generator is available for control applications such as optical source modulation.

#### Basic Equation :

$$V_{\log out} [V] = G_v \times V_y \times \log_{10} \left( \frac{P_{in} \times \eta \times \zeta}{I_z} \right)$$

$$P_{in} [W] = \frac{I_z}{\eta \times \zeta} \times 10^{\left( \frac{V_{\log out}}{G_v \times V_y} \right)}$$

$V_y=200$  mV/decade,  $I_z=100$  pA,  $G_v=1.47$  V/V @ CN2&3, 2.47V/V @ CN1&4,  $P_{in}$ : Input Optical Power[W],  $\eta$ : PD quantum efficiency[A/W],  $\zeta$ : Fiber Bending Loss & CN Loss, default=1

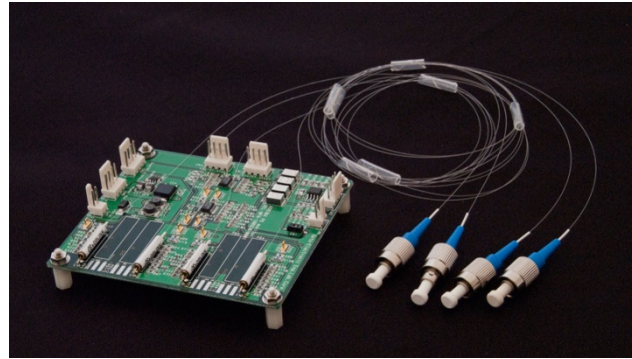
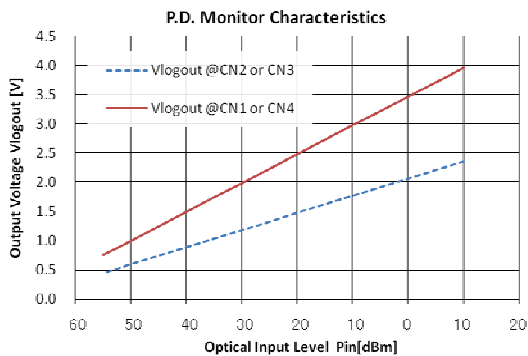

Photodiode is not included with the product.  
(Design by Opto-Electronic Engineering lab.)



#### FEATURES:

- Optimized for Fiber Optic Photodiode Monitoring
- Logarithmic Conversion with Voltage Output
- Wide Photo Diode Current Range 100pA to 10mA
- Output Bandwidth of 10MHz
- 4-Photo Diode Populating Pad/Through Hole on Board
- Single Supply Input Voltage +5V
- 3-Output Supply Voltage +5V/+3V/-5V
- Pulse Generator with 5V-TTL for any kind of application such as Optical Source Modulation
- Operating Temperature Range: -20° C to 60° C
- Board Size 80mm × 90mm

#### APPLICATIONS:

- Optical Power Measurement
- Wide Range Log Compression Photo Diode Monitor

#### Notes:

- For on-off keying applications, the AD8304 VLOG output is delayed 7 msec.
- Design and development by Opto-electric Engineering Lab Corp.

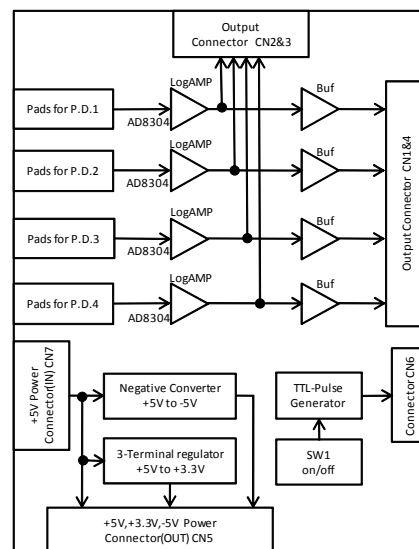

$\eta = 1.03$  A/W  
PIPD-1550-05-0-31-1-2

FUNCTIONAL BLOCK DIAGRAM



Top View of Board OELOGAMP8304

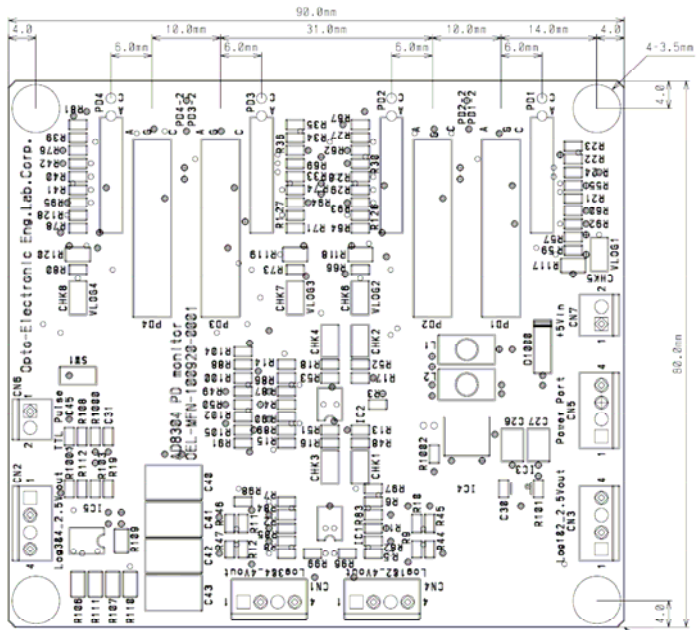

Board Dimensions

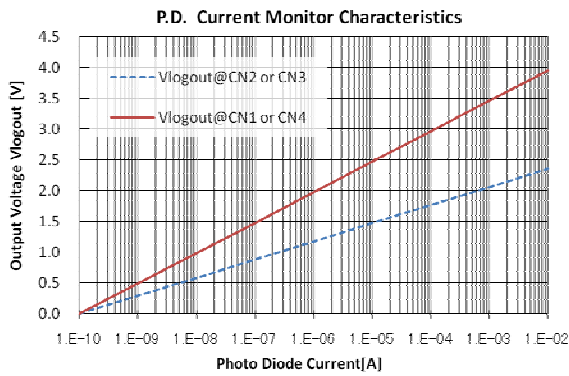

P.D. Current Monitor Characteristics

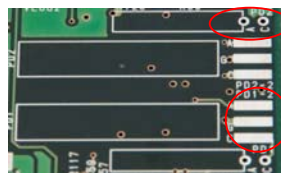

Through-hole for mounting the PD

Solder pads for the PD.

Two mounting types of PD

The board provides solder pads for two types photodiode. Solder pads are labeled A, C, and G for Anode, Cathode, and Ground. A 0Ω resistor selects which type of photodiode is mounted. Only one mounting type can be selected at any given time.

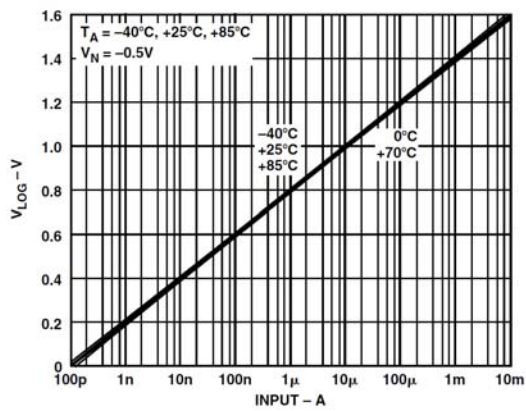

AD8304 Temperature Characteristics

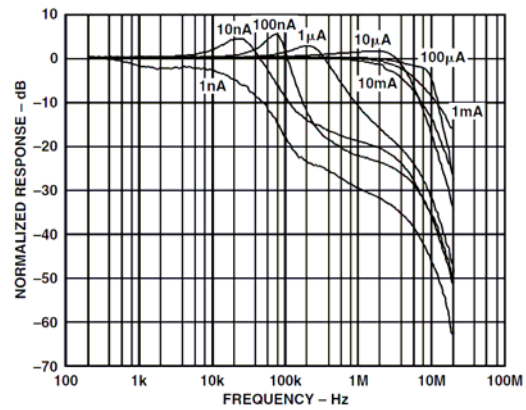

Frequency Band Characteristics